

UN003105-DQ

KIT RICAMBI / PART KITS

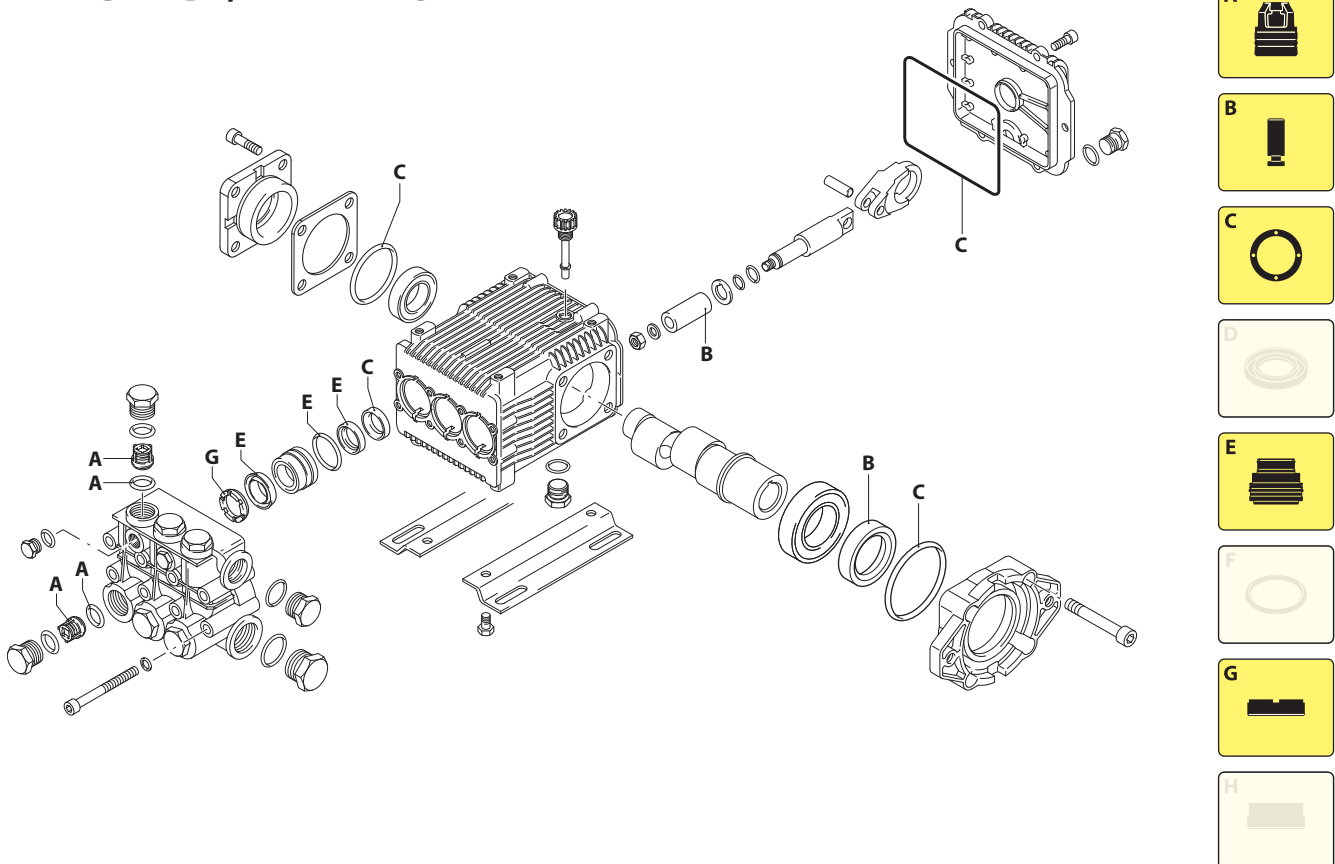

UN003106-DQ

228 Series

HYD - RK



15.15 (21604)
15.20 (21605)
21.15 (22087)

Pos.	Cod.	Denominazione	Description	Qt	Note	Pos.	Cod.	Denominazione	Description	Qt	Note
1	960160	Guarnizione OR Ø 17,86x2,62	O-ring	6		46	1980740	Tappo 3/8" G ottone	Plug	1	C=25Nm
2	960090	Tappo	Plug	6	☉ C=54Nm	47	180101	Guarnizione OR Ø 17,5x2	O-ring	1	
3	1389051	Valvola completa	Complete valve	6		48	820361	Tappo 1/2" G ottone	Plug	1	☉ C=40Nm
4	880830	Guarnizione OR Ø 15,54x2,62	O-ring	6		49	1381071	Testa	Head	1	● ☉
5	880581	Tappo 1/4" G	Plug	2	☉ C=15Nm	50	1380020	Testa	Head	1	○
6	820510	Guarnizione OR Ø 10,82x1,78	O-ring	2		51	820150	Vite TCEI M8x70	Screw	8	C=24,5Nm
11	960110	Anello appoggio Ø18	Ring	3	● ☉	52	1389270	Premontaggio testa	Head assembly	1	● ☉
12	840320	Anello appoggio Ø22	Ring	3	○	53	1389216	Premontaggio testa	Head assembly	1	○
13	1382740	Tenuta acqua Ø 18	Water seal	3	● ☉	54	2281030	Albero marcato 1	Shaft	1	
14	840330	Tenuta acqua Ø 22	Water seal	3	○	55	1383150	Cuscinetto	Bearing	1	
15	1380090	Guida pistone Ø 18	Piston guide	3	● ☉	56	621170	Tenuta olio	Oil seal	1	(a)
16	1380160	Guida pistone Ø 22	Piston guide	3	○	57	1380220	Guarnizione OR Ø 72,75x1,78	O-ring	1	
17	961240	Guarnizione OR Ø 31,47x1,78	O-ring	3		58	1383550	Flangia F38	Flange	1	
18	880330	Tenuta acqua Ø 18	Water seal	3	● ☉	59	180030	Vite TCEI M8x20	Screw	4	C=24,5Nm
19	840340	Tenuta acqua Ø 22	Water seal	3	○	60	1381850	Rondella	Washer	8	
20	880520	Anello tenuta	Ring	3		61	1080401	Anello antiestrusione	Ring	3	
21	850370	Vite TCEI M8x16	Screw	4	C=24,5Nm	62	900270	Rondella	Washer	2	
22	1380050	Supporto cuscinetto chiuso	Supportrv	1		63	540300	Vite TCEI M10x30	Screw	2	C=50Nm
23	640030	Guarnizione OR Ø 59,99x2,62	O-ring	1		64	4769	Motore	Motor	1	(b)
24	2280340	Cuscinetto	Bearing	1		65	1260250	Indicatore livello	Level gauge	1	☉
25	1382770	Corpo pompa	Pump body	1		66	1260430	Anello	Ring	1	☉
26	880130	Tappo	Plug	1		67	1780690	Disco	Plate	1	☉
27	962010	Dado	Nut	3	☉ C=20Nm	68	1140450	Guarnizione OR Ø 20,24x2,62	O-ring	1	☉
28	962000	Rondella	Washer	3							
29	1380940	Pistone Ø 18	Piston	3	● ☉						
30	1382360	Pistone Ø 22	Piston	3	○						
31	1380950	Disco	Plate	3							
32	600180	Guarnizione OR Ø 7,66x1,78	O-ring	3							
33	1380920	Pistone di guida	Piston	3							
34	1380060	Spina	Pin	3							
35	1383050	Biella alluminio	Connecting-rod	3							
36	1780510	Guarnizione OR Ø 106x3	O-ring	1							
37	1789010	Coperchio completo	Cover	1							
38	1343510	Vite TCEI M6x14	Screw	6	C=10Nm						
39	1380120	Spessore 0,10 mm	Shim 0.10 mm	1÷3							
40	1380130	Spessore 0,19 mm	Shim 0.19 mm	1÷3							
41	1380530	Spessore 0,25 mm	Shim 0.25 mm	1÷3							
42	1382810	Spessore 0,05 mm	Shim 0.05 mm	1÷3							
43	740290	Guarnizione OR Ø 14x1,78	O-ring	3	☉						
44	1980740	Tappo 3/8" G ottone	Plug	2	☉ C=20Nm						
45	1263130	Vite TE M8x12	Screw	4							
46	1380141	Piede	Foot	2							

☉ Compreso nel cod. 1789010 / Part of part n° 1789010

KIT RICAMBI - PART KITS

A=KIT 2864 valvole valves		B=KIT 2757 Ø 18 pistoni pistons		B=KIT 2759 Ø 22 pistoni pistons		C=KIT 1856 tenute olio oil seals	
Pos.	Q.ty	Pos.	Q.ty	Pos.	Q.ty	Pos.	Q.ty
3	6	25	3	25	3	16	3
4	6					19	1
						34	1
						61	1
						62	1

E=KIT 1857 Ø 18 tenute acqua water seals		E=KIT 1888 Ø 22 tenute acqua water seals		G=KIT 1829 Ø 18 anelli appoggio support rings		G=KIT 1816 Ø 22 anelli appoggio support rings	
Pos.	Q.ty	Pos.	Q.ty	Pos.	Q.ty	Pos.	Q.ty
12	3	12	3	11	3	11	3
14	3	14	3				
15	3	15	3				

SIMBOLOGIA - SYMBOLS

- Per / For RK 15.15 cod. 21604
- ☉ Per / For RK 15.20 cod. 21605
- Per / For RK 21.15 cod. 22087

- C Tolleranza coppia di serraggio +0÷-10% / Tightening torque tolerance +0÷-10%
- ☉ Avvitare con Loxeal 55-14 / Screw with Loxeal 55-14
- (a) Montare anello tenuta con attrezzo cod. 1781000 / Fit the seal with tool code nr. 1781000
- (b) Il drenaggio deve essere libero nel serbatoio (nessuna contropressione) / The drainage must be free in the tank (no counter pressure)
- @ Posizionamento targa di identificazione / Identification plate positioning

Olio - Oil

Tipo / Type	Quantità / Quantity
SAE 15W40	0,43 Kg